

**PDFN3.3X3.3-8 N Channel Enhancement 沟道增强型
MOS Field Effect Transistor 场效应管**

■ Features 特点

Low on-resistance 低导通电阻
 $R_{DS(ON)}=4.5m\Omega(\text{Type})@V_{GS}=10V$
 $R_{DS(ON)}=6.9m\Omega(\text{Type})@V_{GS}=4.5V$

■ Applications 应用

Load Switch 负载开关
 Portable Equipment 桌面设备
 Power Management 电源管理

■ Internal Schematic Diagram 内部结构

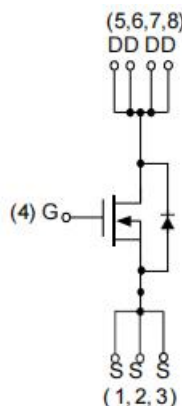
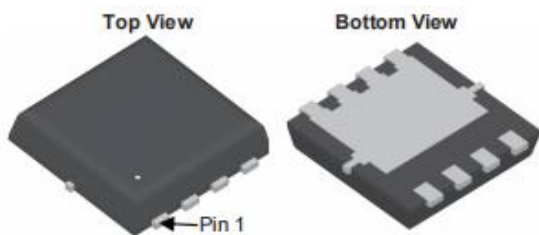

■ Absolute Maximum Ratings 最大额定值

Characteristic 特性参数	Symbol 符号	Rat 额定值	Unit 单位
Drain-Source Voltage 漏极-源极电压	BV_{DSS}	30	V
Gate- Source Voltage 栅极-源极电压	V_{GS}	± 20	V
Drain Current (continuous)漏极电流-连续	I_D (at $T_C = 25^\circ\text{C}$ at $T_A = 25^\circ\text{C}$)	44 12	A
Drain Current (pulsed)漏极电流-脉冲	I_{DM}	100	A
Total Device Dissipation 总耗散功率	P_{TOT} (at $T_C = 25^\circ\text{C}$ at $T_A = 25^\circ\text{C}$)	26.6 1.73	W
Avalanche Energy(Single Pulse)雪崩能量	E_{AS}	20	mJ
Thermal Resistance Junction-Ambient 热阻	$R_{\theta JC}/R_{\theta JA}$	4.7/72	$^\circ\text{C}/\text{W}$
Junction/Storage Temperature 结温/储存温度	T_J, T_{stg}	-55~150	$^\circ\text{C}$

■ **Electrical Characteristics** 电特性

($T_A=25^{\circ}\text{C}$ unless otherwise noted 如无特殊说明, 温度为 25°C)

Characteristic 特性参数	Symbol 符号	Min 最小值	Typ 典型值	Max 最大值	Unit 单位
Drain-Source Breakdown Voltage 漏极-源极击穿电压($I_D=250\mu\text{A}, V_{GS}=0\text{V}$)	BV_{DSS}	30	—	—	V
Gate Threshold Voltage 栅极开启电压($I_D=250\mu\text{A}, V_{GS}=V_{DS}$)	$V_{GS(th)}$	1.4	1.7	2.5	V
Zero Gate Voltage Drain Current 零栅压漏极电流($V_{GS}=0\text{V}, V_{DS}=24\text{V}$)	I_{DSS}	—	—	1	μA
Gate Body Leakage 栅极漏电流($V_{GS}=\pm 20\text{V}, V_{DS}=0\text{V}$)	I_{GSS}	—	—	± 100	nA
Static Drain-Source On-State Resistance 静态漏源导通电阻($I_D=12\text{A}, V_{GS}=10\text{V}$) ($I_D=9\text{A}, V_{GS}=4.5\text{V}$)	$R_{DS(ON)}$	—	4.5 6.9	5.5 8.7	$\text{m}\Omega$
Diode Forward Voltage Drop 内附二极管正向压降($I_{SD}=2\text{A}, V_{GS}=0\text{V}$)	V_{SD}	—	0.8	1.1	V
Input Capacitance 输入电容 ($V_{GS}=0\text{V}, V_{DS}=15\text{V}, f=1\text{MHz}$)	C_{ISS}	—	750	—	pF
Common Source Output Capacitance 共源输出电容($V_{GS}=0\text{V}, V_{DS}=15\text{V}, f=1\text{MHz}$)	C_{OSS}	—	530	—	pF
Reverse Transfer Capacitance 反馈电容 ($V_{GS}=0\text{V}, V_{DS}=15\text{V}, f=1\text{MHz}$)	C_{RSS}	—	37	—	pF
Total Gate Charge 栅极电荷密度 ($V_{DS}=15\text{V}, I_D=12\text{A}, V_{GS}=4.5\text{V}$)	Q_g	—	6	—	nC
Gate Source Charge 栅源电荷密度 ($V_{DS}=15\text{V}, I_D=12\text{A}, V_{GS}=4.5\text{V}$)	Q_{gs}	—	2	—	nC
Gate Drain Charge 栅漏电荷密度 ($V_{DS}=15\text{V}, I_D=12\text{A}, V_{GS}=4.5\text{V}$)	Q_{gd}	—	3	—	nC
Turn-ON Delay Time 开启延迟时间 ($V_{DS}=15\text{V}, I_D=1\text{A}, R_{GEN}=1\Omega, V_{GS}=10\text{V}$)	$t_{d(on)}$	—	9	—	ns
Turn-ON Rise Time 开启上升时间 ($V_{DS}=15\text{V}, I_D=1\text{A}, R_{GEN}=1\Omega, V_{GS}=10\text{V}$)	t_r	—	10	—	ns
Turn-OFF Delay Time 关断延迟时间 ($V_{DS}=15\text{V}, I_D=1\text{A}, R_{GEN}=1\Omega, V_{GS}=10\text{V}$)	$t_{d(off)}$	—	20	—	ns
Turn-OFF Fall Time 关断下降时间 ($V_{DS}=15\text{V}, I_D=1\text{A}, R_{GEN}=1\Omega, V_{GS}=10\text{V}$)	t_f	—	18	—	ns

■ Typical Characteristic Curve 典型特性曲线

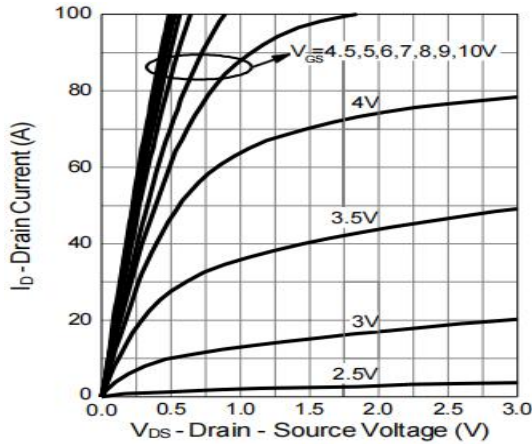

Figure 1: Output Characteristics

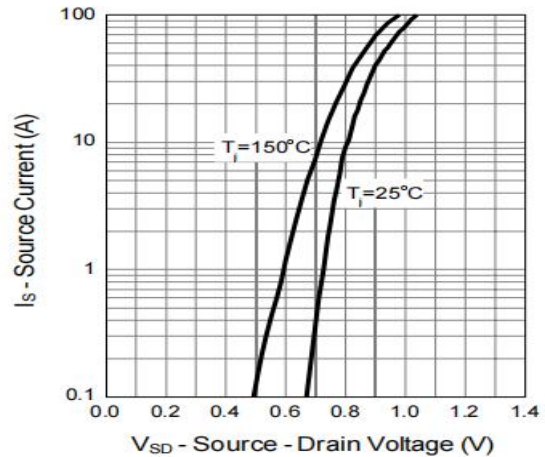

Figure 2: Diode Forward Characteristics

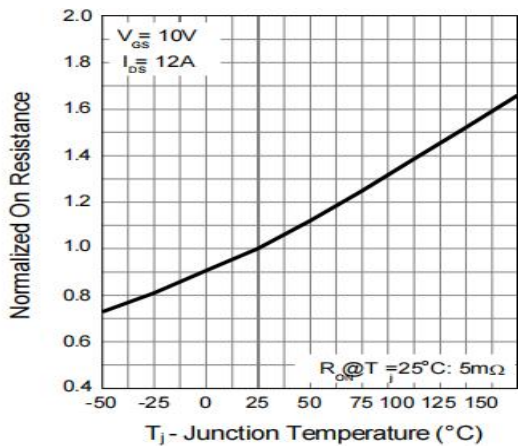

Figure 3: On-Resistance vs. T_j

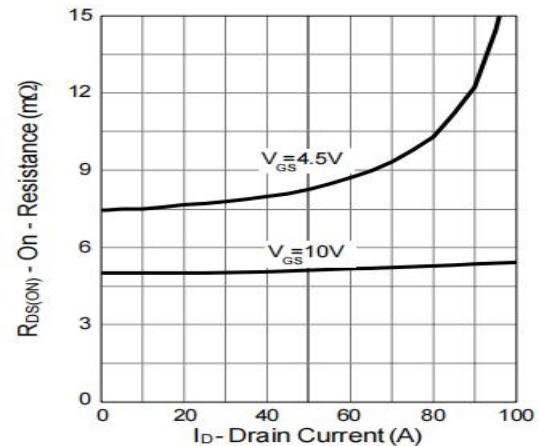

Figure 4: On-Resistance vs. Drain Current

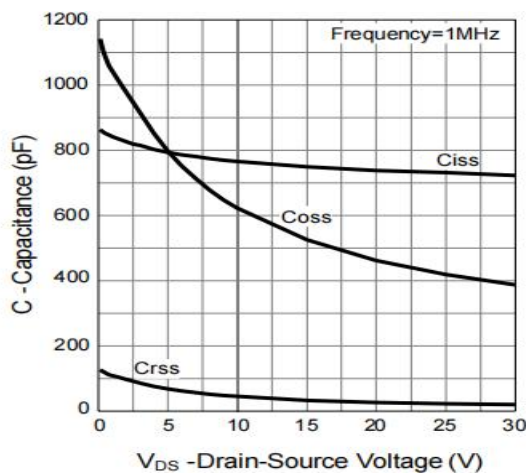

Figure 5: Capacitance Characteristics

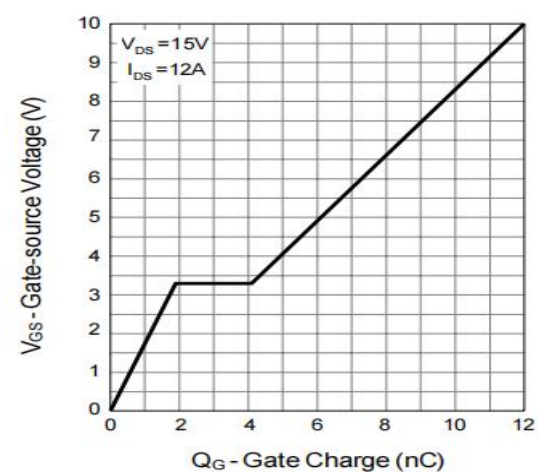

Figure 6: Gate-Charge Characteristics

■ Typical Characteristic Curve 典型特性曲线

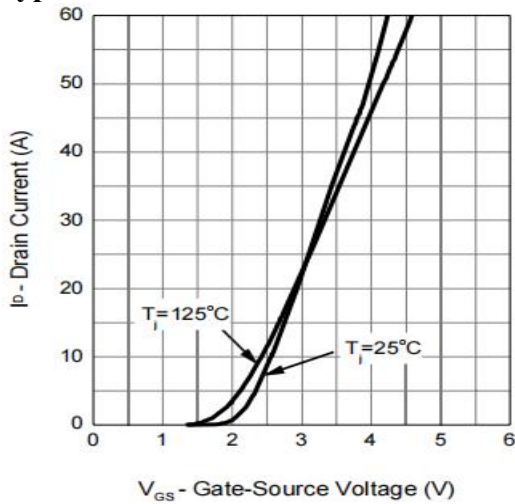

Figure 7: Transfer Characteristics

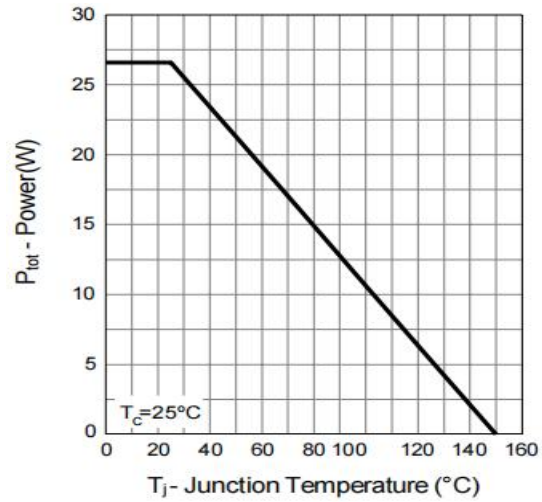

Figure 8: Power Rating Curve

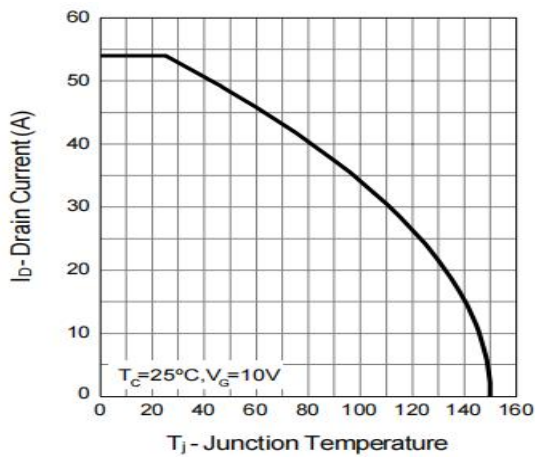

Figure 9: Drain Current Characteristics

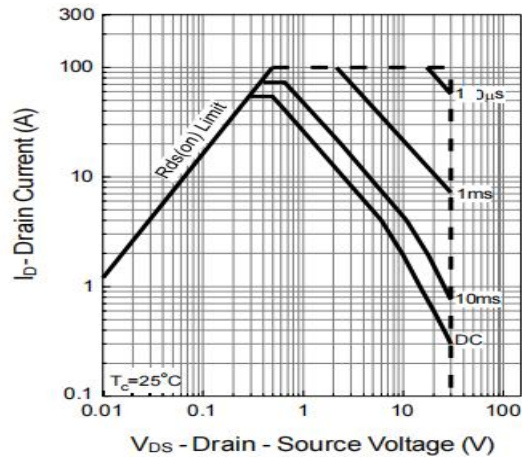

Figure 10: Safe Operating Area

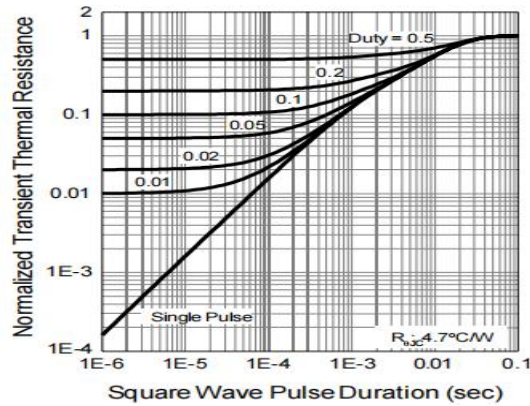
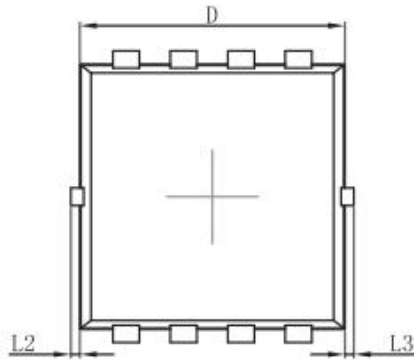
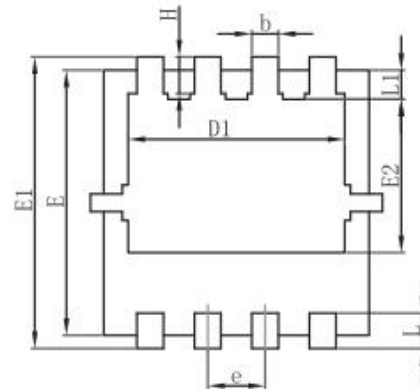

Figure 11: Transient Thermal Response Curve

■ Dimension 外形封装尺寸



Top View



Bottom View

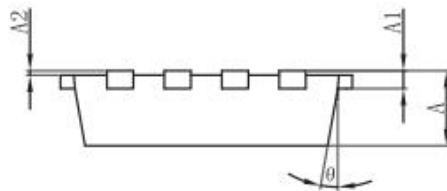

Side View

Symbol	Dimensions In Millimeters		Dimensions In Inches	
	Min.	Max.	Min.	Max.
A	0.650	0.850	0.026	0.033
A1	0.152 REF.		0.006 REF.	
A2	0~0.05		0~0.002	
D	2.900	3.100	0.114	0.122
D1	2.300	2.600	0.091	0.102
E	2.900	3.100	0.114	0.122
E1	3.150	3.450	0.124	0.136
E2	1.535	1.935	0.060	0.076
b	0.200	0.400	0.008	0.016
e	0.550	0.750	0.022	0.030
L	0.300	0.500	0.012	0.020
L1	0.180	0.480	0.007	0.019
L2	0~0.100		0~0.004	
L3	0~0.100		0~0.004	
H	0.315	0.515	0.012	0.020
θ	9°	13°	9°	13°