

**TSSOP-8 20V Dual N Channel Enhancement with ESD 双 N 沟道增强型带静电保护
MOS Field Effect Transistor 场效应管**

■ Features 特点

Low on-resistance 低导通电阻

$R_{DS(ON)}=12.5m\Omega(\text{Type})@V_{GS}=4.5V$

$R_{DS(ON)}=16m\Omega(\text{Type})@V_{GS}=2.5V$

$R_{DS(ON)}=22m\Omega(\text{Type})@V_{GS}=1.8V$

■ Applications 应用

Portable Equipment 桌面设备

Battery Powered System 电池电源系统

Power Management in Note Book 笔记本电源管理

■ Internal Schematic Diagram 内部结构

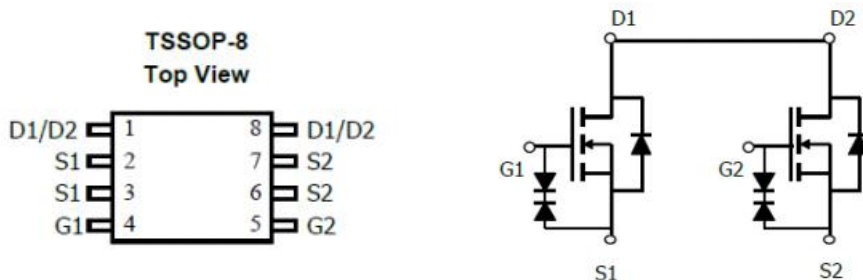

■ Absolute Maximum Ratings 最大额定值

Characteristic 特性参数	Symbol 符号	Rat 额定值	Unit 单位
Drain-Source Voltage 漏极-源极电压	BV_{DSS}	20	V
Gate- Source Voltage 栅极-源极电压	V_{GS}	± 10	V
Drain Current (continuous)漏极电流-连续	I_D (at $T_A = 25^\circ\text{C}$)	7	A
Drain Current (pulsed)漏极电流-脉冲	I_{DM}	30	A
Total Device Dissipation 总耗散功率	$P_D(\text{at } T_A = 25^\circ\text{C})$	1500	mW
Thermal Resistance Junction-Ambient 热阻	$R_{\theta JA}$	83	$^\circ\text{C}/\text{W}$
Junction/Storage Temperature 结温/储存温度	T_J, T_{stg}	-55~150	$^\circ\text{C}$

■ Electrical Characteristics 电特性

($T_A=25^{\circ}\text{C}$ unless otherwise noted 如无特殊说明, 温度为 25°C)

Characteristic 特性参数	Symbol 符号	Min 最小值	Typ 典型值	Max 最大值	Unit 单位
Drain-Source Breakdown Voltage 漏极-源极击穿电压($I_D=250\mu\text{A}, V_{GS}=0\text{V}$)	BV_{DSS}	20	—	—	V
Gate Threshold Voltage 栅极开启电压($I_D=250\mu\text{A}, V_{GS}=V_{DS}$)	$V_{GS(th)}$	0.4	0.75	1.0	V
Zero Gate Voltage Drain Current 零栅压漏极电流($V_{GS}=0\text{V}, V_{DS}=20\text{V}$)	I_{DSS}	—	—	1	μA
Gate Body Leakage 栅极漏电流($V_{GS}=\pm 8\text{V}, V_{DS}=0\text{V}$)	I_{GSS}	—	—	± 10	μA
Static Drain-Source On-State Resistance 静态漏源导通电阻($I_D=7\text{A}, V_{GS}=4.5\text{V}$) ($I_D=6.5\text{A}, V_{GS}=2.5\text{V}$) ($I_D=5\text{A}, V_{GS}=1.8\text{V}$)	$R_{DS(ON)}$	—	12.5 16 22	19 22 30	$\text{m}\Omega$
Diode Forward Voltage Drop 内附二极管正向压降($I_{SD}=1\text{A}, V_{GS}=0\text{V}$)	V_{SD}	—	0.7	1.3	V
Input Capacitance 输入电容 ($V_{GS}=0\text{V}, V_{DS}=10\text{V}, f=1\text{MHz}$)	C_{ISS}	—	1300	—	pF
Common Source Output Capacitance 共源输出电容($V_{GS}=0\text{V}, V_{DS}=10\text{V}, f=1\text{MHz}$)	C_{OSS}	—	195	—	pF
Reverse Transfer Capacitance 反馈电容 ($V_{GS}=0\text{V}, V_{DS}=10\text{V}, f=1\text{MHz}$)	C_{RSS}	—	155	—	pF
Total Gate Charge 栅极电荷密度 ($V_{DS}=10\text{V}, I_D=7\text{A}, V_{GS}=4.5\text{V}$)	Q_g	—	16	—	nC
Gate Source Charge 栅源电荷密度 ($V_{DS}=10\text{V}, I_D=7\text{A}, V_{GS}=4.5\text{V}$)	Q_{gs}	—	2	—	nC
Gate Drain Charge 栅漏电荷密度 ($V_{DS}=10\text{V}, I_D=7\text{A}, V_{GS}=4.5\text{V}$)	Q_{gd}	—	7	—	nC
Turn-ON Delay Time 开启延迟时间 ($V_{DS}=10\text{V}, I_D=7\text{A}, R_{GEN}=3.3\Omega, V_{GS}=4.5\text{V}$)	$t_{d(on)}$	—	7	—	ns
Turn-ON Rise Time 开启上升时间 ($V_{DS}=10\text{V}, I_D=7\text{A}, R_{GEN}=3.3\Omega, V_{GS}=4.5\text{V}$)	t_r	—	11	—	ns
Turn-OFF Delay Time 关断延迟时间 ($V_{DS}=10\text{V}, I_D=7\text{A}, R_{GEN}=3.3\Omega, V_{GS}=4.5\text{V}$)	$t_{d(off)}$	—	64	—	ns
Turn-OFF Fall Time 关断下降时间 ($V_{DS}=10\text{V}, I_D=7\text{A}, R_{GEN}=3.3\Omega, V_{GS}=4.5\text{V}$)	t_f	—	32	—	ns

■ Typical Characteristic Curve 典型特性曲线

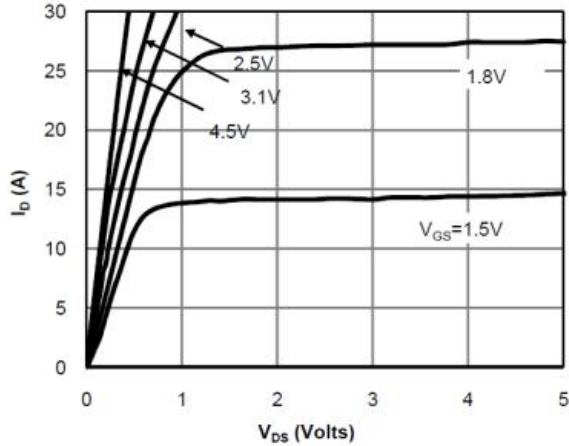

Figure 1: Output Characteristics

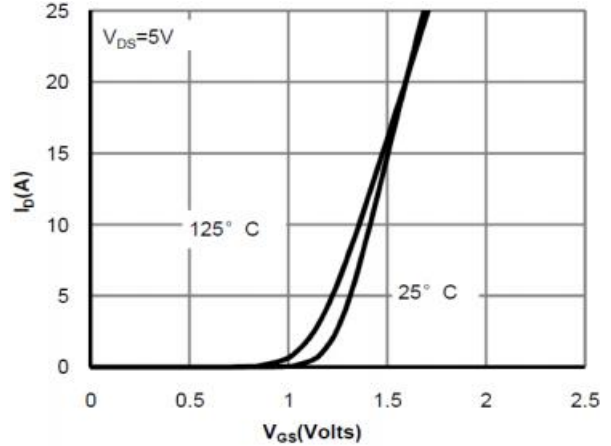

Figure 2: Transfer Characteristics

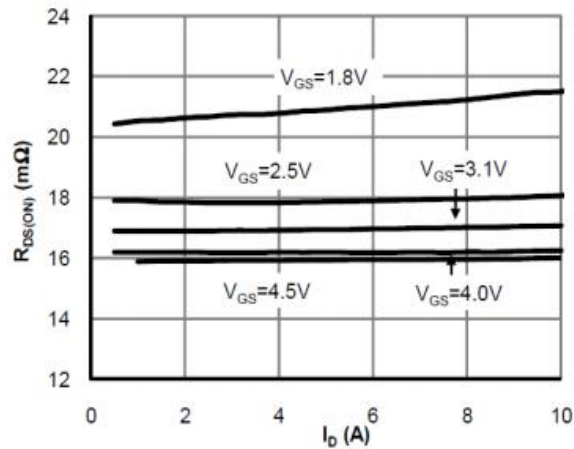

Figure 3: On-Resistance vs. Drain Current

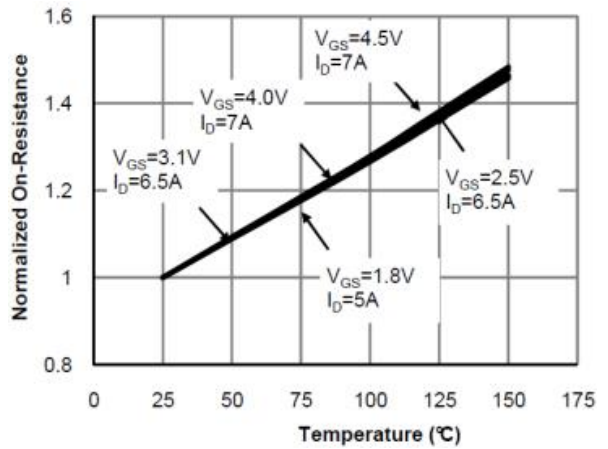

Figure 4: On-Resistance vs. Temperature

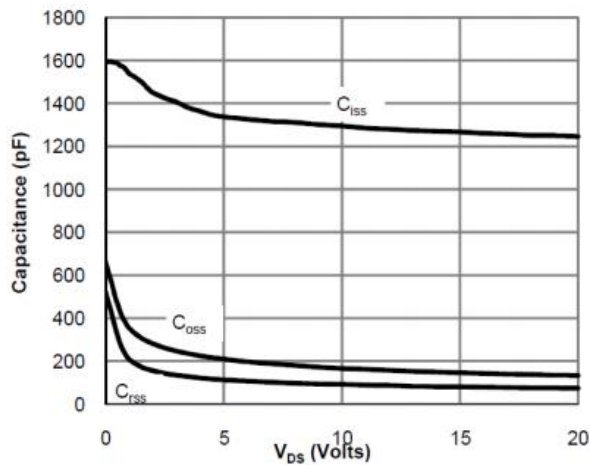

Figure 5: Capacitance Characteristics

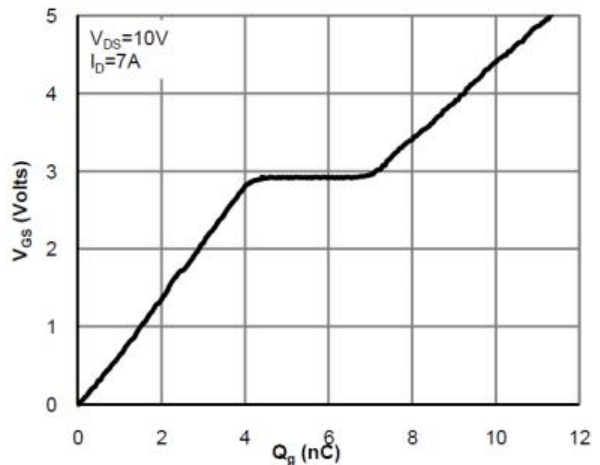

Figure 6: Gate-Charge Characteristics

■ Typical Characteristic Curve 典型特性曲线

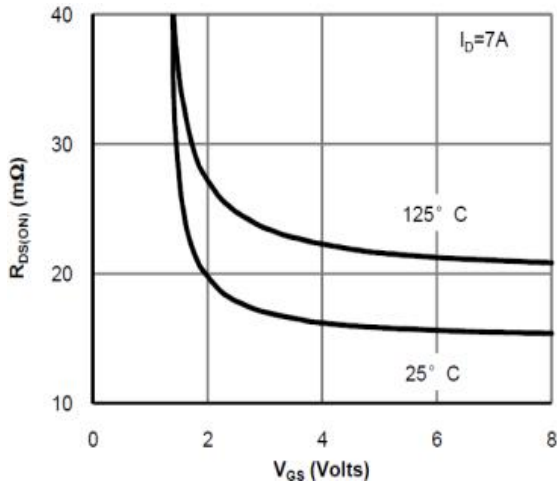

Figure 7: Drain Current vs. V_{GS}

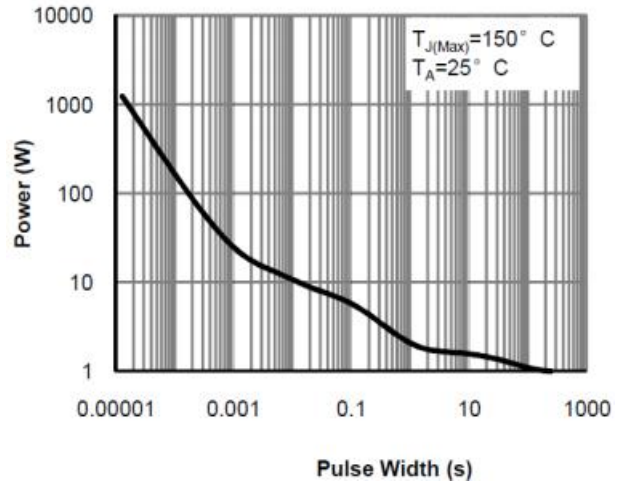

Figure 8: Power Rating Curve

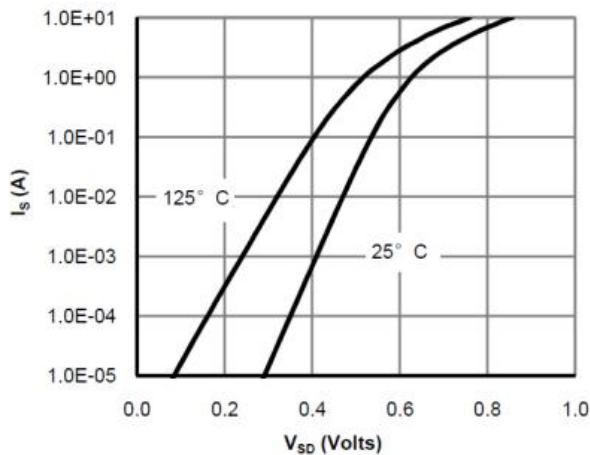

Figure 9: Diode Characteristics

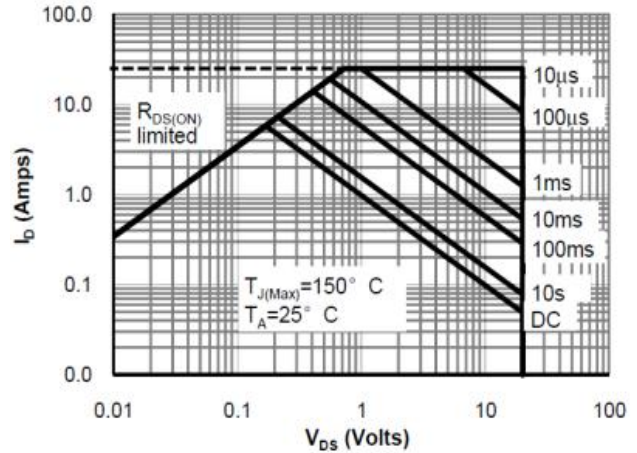

Figure 10: Safe Operating Area

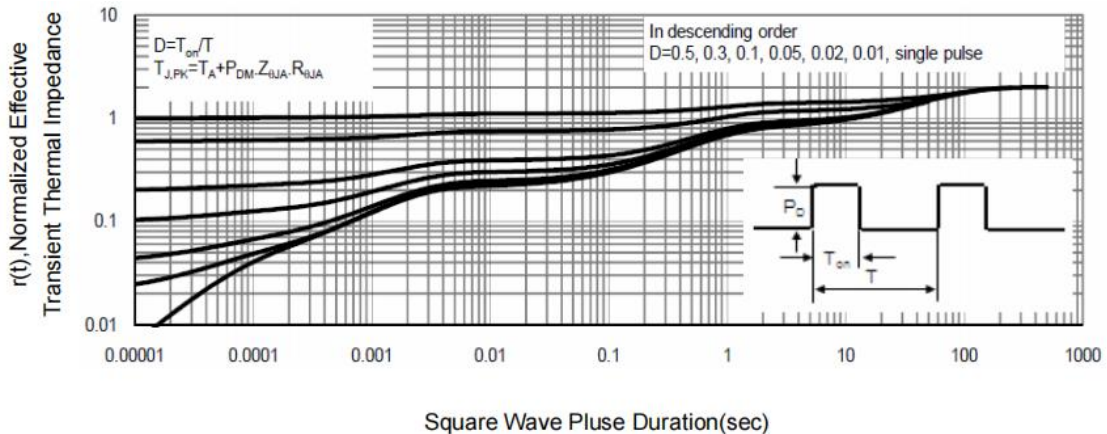
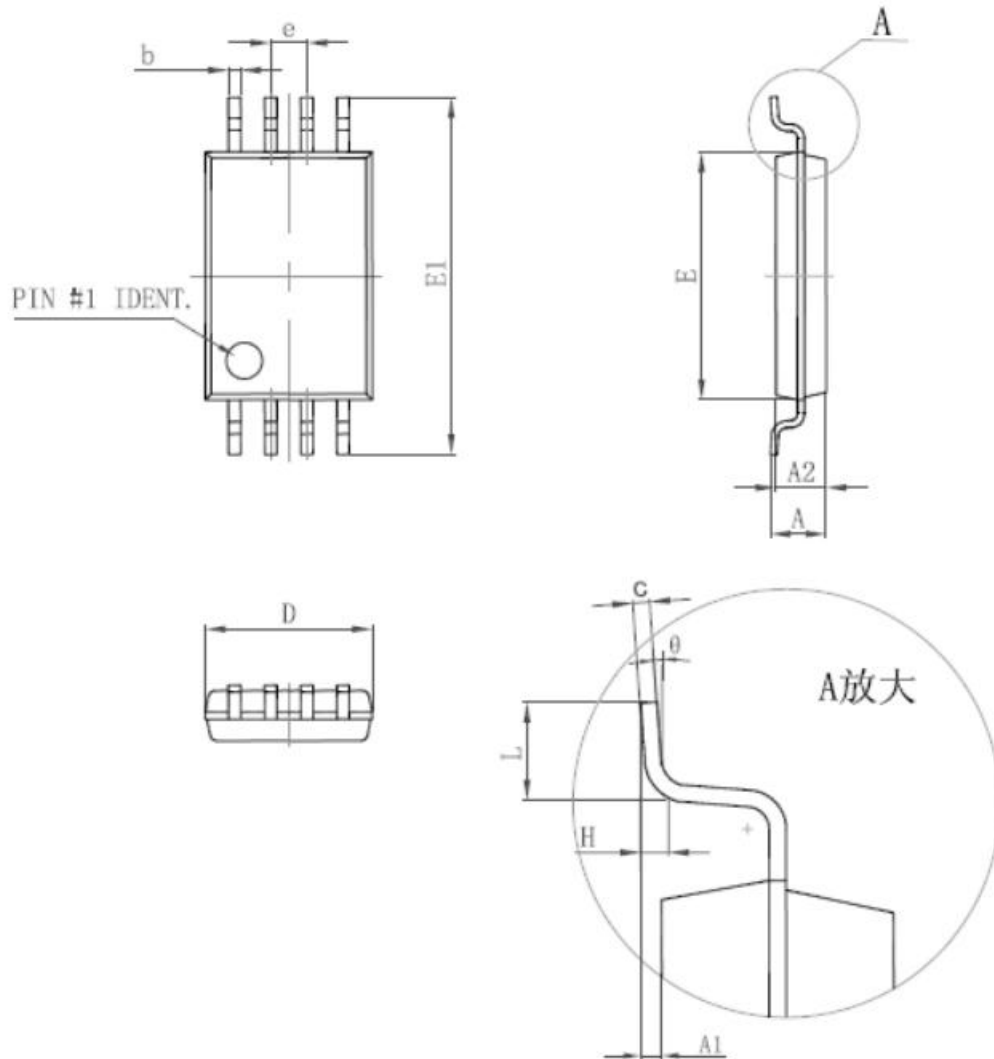

Figure 11: Transient Thermal Response Curve

■ Dimension 外形封装尺寸



Symbol	Dimensions In Millimeters		Dimensions In Inches	
	Min	Max	Min	Max
D	2.900	3.100	0.114	0.122
E	4.300	4.500	0.169	0.177
b	0.190	0.300	0.007	0.012
c	0.090	0.200	0.004	0.008
E1	6.250	6.550	0.246	0.258
A		1.100		0.043
A2	0.800	1.000	0.031	0.039
A1	0.020	0.150	0.001	0.006
e	0.65 (BSC)		0.026 (BSC)	
L	0.500	0.700	0.020	0.028
H	0.25 (TYP)		0.01 (TYP)	
θ	1°	7°	1°	7°