

**SOP-8 N+P Dual Enhancement 互补双沟道增强型  
MOS Field Effect Transistor 场效应管**

**■ Features 特点**

Low on-resistance 低导通电阻

N:  $R_{DS(ON)}=21m\Omega(\text{Type})@V_{GS}=10V$

$R_{DS(ON)}=25m\Omega(\text{Type})@V_{GS}=4.5V$

P:  $R_{DS(ON)}=33m\Omega(\text{Type})@V_{GS}= -10V$

$R_{DS(ON)}=43m\Omega@(\text{Type})V_{GS}= -4.5V$

**■ Applications 应用**

Motor Control 马达控制

Synchronous Rectification 同步整流

Fan Pre-drive H-bridge 风扇预驱动半桥

**■ Internal Schematic Diagram 内部结构**

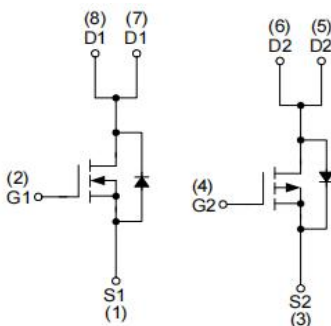
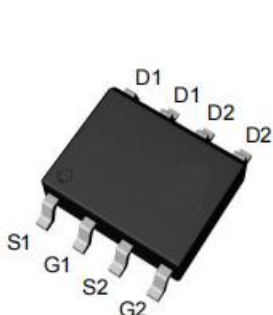

**■ Absolute Maximum Ratings 最大额定值**

Characteristic 特性参数	Symbol 符号	N	P	Unit 单位
Drain-Source Voltage 漏极-源极电压	$BV_{DSS}$	40	-40	V
Gate- Source Voltage 栅极-源极电压	$V_{GS}$	$\pm 20$	$\pm 20$	V
Drain Current (continuous)漏极电流-连续	$I_D$ (at $T_A = 25^\circ C$ at $T_A = 70^\circ C$ )	7.5 6	-5.5 -4.5	A
Drain Current (pulsed)漏极电流-脉冲	$I_{DM}$	30	-22	A
Total Device Dissipation 总耗散功率	$P_{TOT}$ (at $T_A = 25^\circ C$ at $T_A = 70^\circ C$ )	2 1.3		W
Thermal Resistance Junction-Ambient 热阻	$R_{\theta JA}$	62.5		$^\circ C/W$
Avalanche Energy Single Pulse 雪崩能量	$E_{AS}$	25		mJ
Junction/Storage Temperature 结温/储存温度	$T_J, T_{stg}$	-55~150		$^\circ C$

■ **N Electrical Characteristics 电特性**

( $T_A=25^{\circ}\text{C}$  unless otherwise noted 如无特殊说明, 温度为  $25^{\circ}\text{C}$ )

Characteristic 特性参数	Symbol 符号	Min 最小值	Typ 典型值	Max 最大值	Unit 单位
Drain-Source Breakdown Voltage 漏极-源极击穿电压( $I_D=250\mu\text{A}, V_{GS}=0\text{V}$ )	$BV_{DSS}$	40	—	—	V
Gate Threshold Voltage 栅极开启电压( $I_D=250\mu\text{A}, V_{GS}=V_{DS}$ )	$V_{GS(th)}$	1.0	1.5	2.0	V
Zero Gate Voltage Drain Current 零栅压漏极电流( $V_{GS}=0\text{V}, V_{DS}=32\text{V}$ )	$I_{DSS}$	—	—	1	$\mu\text{A}$
Gate Body Leakage 栅极漏电流( $V_{GS}=\pm 20\text{V}, V_{DS}=0\text{V}$ )	$I_{GSS}$	—	—	$\pm 100$	nA
Static Drain-Source On-State Resistance 静态漏源导通电阻( $I_D=6\text{A}, V_{GS}=10\text{V}$ ) ( $I_D=3\text{A}, V_{GS}=4.5\text{V}$ )	$R_{DS(ON)}$	—	21 25	25 35	$\text{m}\Omega$
Diode Forward Voltage Drop 内附二极管正向压降( $I_{SD}=1\text{A}, V_{GS}=0\text{V}$ )	$V_{SD}$	—	0.75	1.1	V
Input Capacitance 输入电容 ( $V_{GS}=0\text{V}, V_{DS}=20\text{V}, f=1\text{MHz}$ )	$C_{ISS}$	—	815	—	pF
Common Source Output Capacitance 共源输出电容( $V_{GS}=0\text{V}, V_{DS}=20\text{V}, f=1\text{MHz}$ )	$C_{OSS}$	—	95	—	pF
Reverse Transfer Capacitance 反馈电容 ( $V_{GS}=0\text{V}, V_{DS}=20\text{V}, f=1\text{MHz}$ )	$C_{RSS}$	—	60	—	pF
Total Gate Charge 栅极电荷密度 ( $V_{DS}=20\text{V}, I_D=6\text{A}, V_{GS}=4.5\text{V}$ )	$Q_g$	—	8	—	nC
Gate Source Charge 栅源电荷密度 ( $V_{DS}=20\text{V}, I_D=6\text{A}, V_{GS}=4.5\text{V}$ )	$Q_{gs}$	—	3	—	nC
Gate Drain Charge 栅漏电荷密度 ( $V_{DS}=20\text{V}, I_D=6\text{A}, V_{GS}=4.5\text{V}$ )	$Q_{gd}$	—	3	—	nC
Turn-ON Delay Time 开启延迟时间 ( $V_{DS}=20\text{V}, I_D=1\text{A}, R_{GEN}=6\Omega, V_{GS}=10\text{V}$ )	$t_{d(on)}$	—	8	—	ns
Turn-ON Rise Time 开启上升时间 ( $V_{DS}=20\text{V}, I_D=1\text{A}, R_{GEN}=6\Omega, V_{GS}=10\text{V}$ )	$t_r$	—	7	—	ns
Turn-OFF Delay Time 关断延迟时间 ( $V_{DS}=20\text{V}, I_D=1\text{A}, R_{GEN}=6\Omega, V_{GS}=10\text{V}$ )	$t_{d(off)}$	—	22	—	ns
Turn-OFF Fall Time 关断下降时间 ( $V_{DS}=20\text{V}, I_D=1\text{A}, R_{GEN}=6\Omega, V_{GS}=10\text{V}$ )	$t_f$	—	5	—	ns

### ■ P Electrical Characteristics 电特性

( $T_A=25^{\circ}\text{C}$  unless otherwise noted 如无特殊说明, 温度为  $25^{\circ}\text{C}$ )

Characteristic 特性参数	Symbol 符号	Min 最小值	Typ 典型值	Max 最大值	Unit 单位
Drain-Source Breakdown Voltage 漏极-源极击穿电压( $I_D = -250\mu\text{A}, V_{GS}=0\text{V}$ )	$BV_{DSS}$	-40	—	—	V
Gate Threshold Voltage 栅极开启电压( $I_D = -250\mu\text{A}, V_{GS} = V_{DS}$ )	$V_{GS(th)}$	-1.0	-1.65	-2.5	V
Zero Gate Voltage Drain Current 零栅压漏极电流( $V_{GS}=0\text{V}, V_{DS} = -32\text{V}$ )	$I_{DSS}$	—	—	-1	$\mu\text{A}$
Gate Body Leakage 栅极漏电流( $V_{GS}=\pm 20\text{V}, V_{DS}=0\text{V}$ )	$I_{GSS}$	—	—	$\pm 100$	nA
Static Drain-Source On-State Resistance 静态漏源导通电阻( $I_D = -5.5\text{A}, V_{GS} = -10\text{V}$ ) ( $I_D = -3.5\text{A}, V_{GS} = -4.5\text{V}$ )	$R_{DS(ON)}$	—	33 43	38 52	$\text{m}\Omega$
Diode Forward Voltage Drop 内附二极管正向压降( $I_{SD} = -1\text{A}, V_{GS}=0\text{V}$ )	$V_{SD}$	—	-0.75	-1.0	V
Input Capacitance 输入电容 ( $V_{GS}=0\text{V}, V_{DS} = -20\text{V}, f=1\text{MHz}$ )	$C_{ISS}$	—	1068	—	pF
Common Source Output Capacitance 共源输出电容( $V_{GS}=0\text{V}, V_{DS} = -20\text{V}, f=1\text{MHz}$ )	$C_{OSS}$	—	98	—	pF
Reverse Transfer Capacitance 反馈电容 ( $V_{GS}=0\text{V}, V_{DS} = -20\text{V}, f=1\text{MHz}$ )	$C_{RSS}$	—	72	—	pF
Total Gate Charge 栅极电荷密度 ( $V_{DS} = -20\text{V}, I_D = -5.5\text{A}, V_{GS} = -4.5\text{V}$ )	$Q_g$	—	8	—	nC
Gate Source Charge 栅源电荷密度 ( $V_{DS} = -20\text{V}, I_D = -5.5\text{A}, V_{GS} = -4.5\text{V}$ )	$Q_{gs}$	—	2	—	nC
Gate Drain Charge 栅漏电荷密度 ( $V_{DS} = -20\text{V}, I_D = -5.5\text{A}, V_{GS} = -4.5\text{V}$ )	$Q_{gd}$	—	3	—	nC
Turn-ON Delay Time 开启延迟时间 ( $V_{DS} = -20\text{V}, I_D = -1\text{A}, R_{GEN}=6\Omega, V_{GS} = -10\text{V}$ )	$t_{d(on)}$	—	9	—	ns
Turn-ON Rise Time 开启上升时间 ( $V_{DS} = -20\text{V}, I_D = -1\text{A}, R_{GEN}=6\Omega, V_{GS} = -10\text{V}$ )	$t_r$	—	8	—	ns
Turn-OFF Delay Time 关断延迟时间 ( $V_{DS} = -20\text{V}, I_D = -1\text{A}, R_{GEN}=6\Omega, V_{GS} = -10\text{V}$ )	$t_{d(off)}$	—	31	—	ns
Turn-OFF Fall Time 关断下降时间 ( $V_{DS} = -20\text{V}, I_D = -1\text{A}, R_{GEN}=6\Omega, V_{GS} = -10\text{V}$ )	$t_f$	—	18	—	ns

■ N Typical Characteristic Curve 典型特性曲线

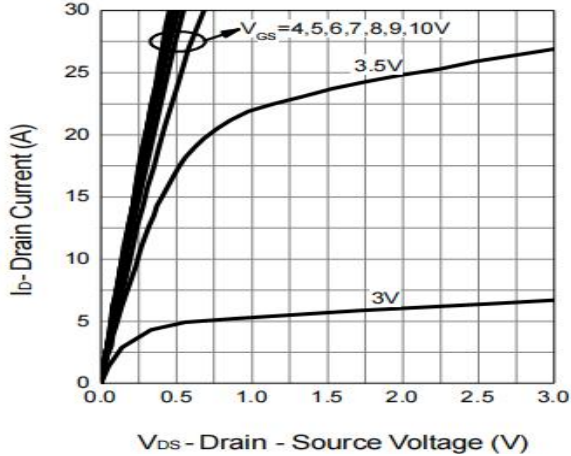

Figure 1: Output Characteristics

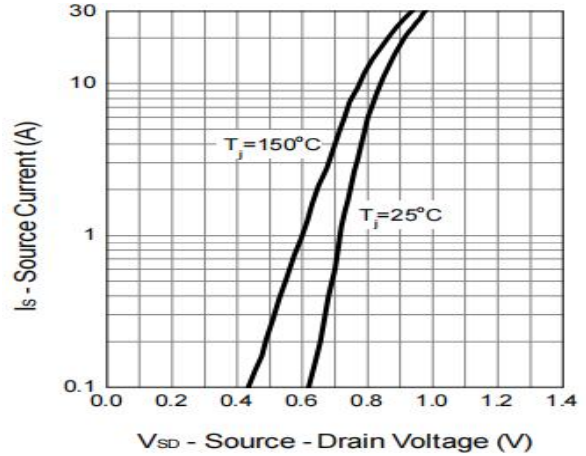

Figure 2: Diode Forward Characteristics

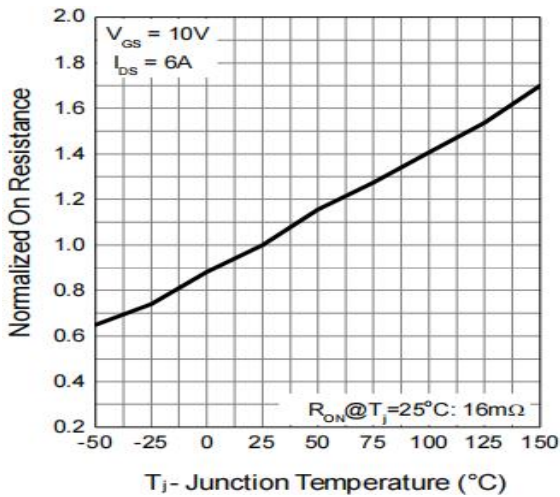

Figure 3: On-Resistance vs.  $T_j$

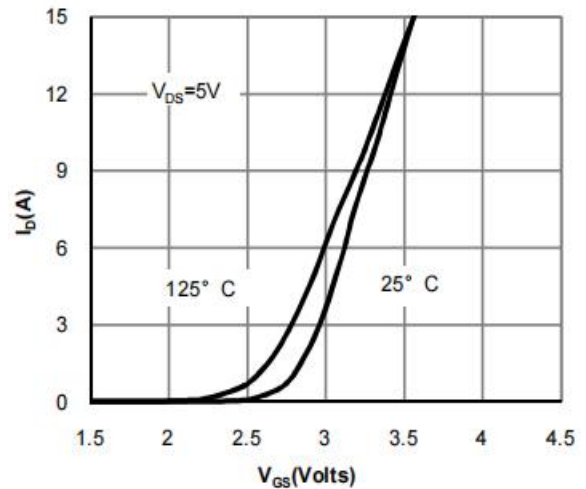

Figure 4: Transfer Characteristics

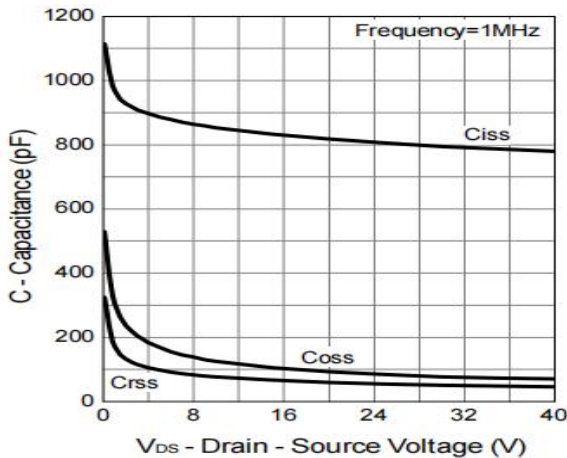

Figure 5: Capacitance Characteristics

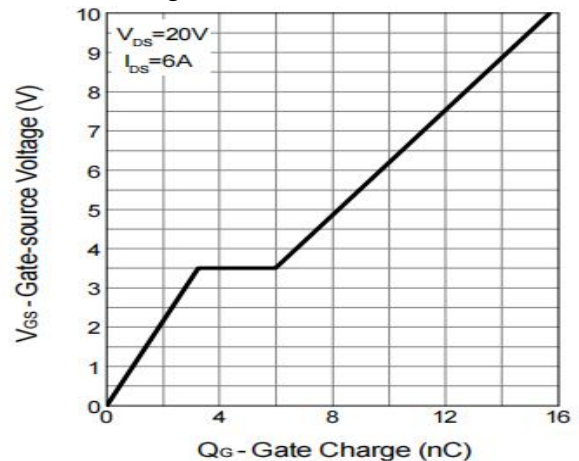

Figure 6: Gate-Charge Characteristics

■ N Typical Characteristic Curve 典型特性曲线

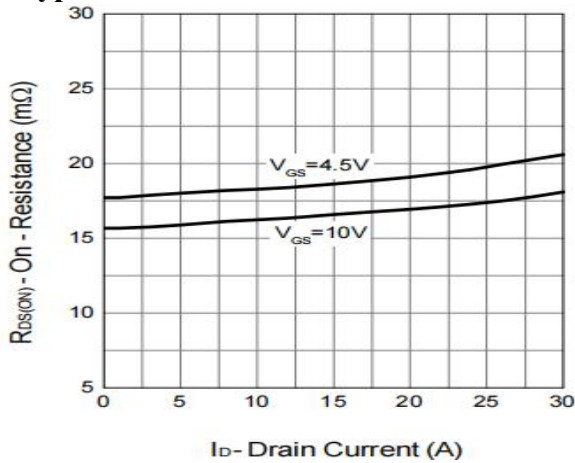

Figure 7: On-Resistance vs. Drain Current

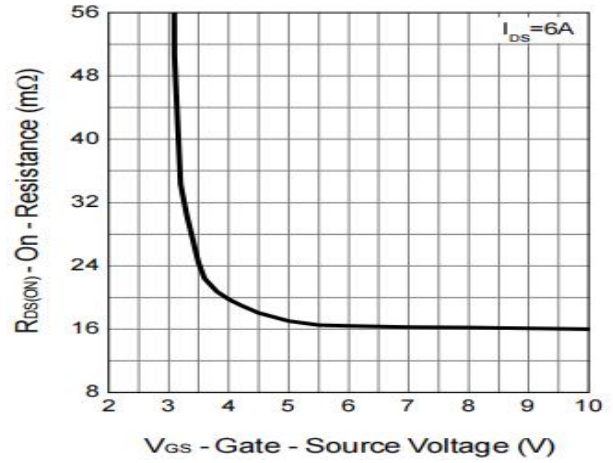

Figure 8: On-Resistance vs.  $V_{GS}$

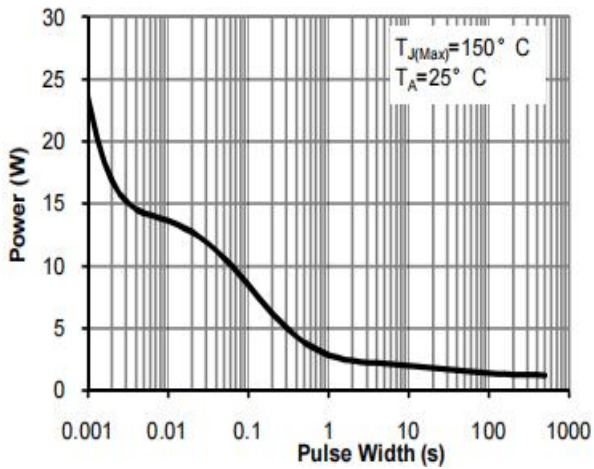

Figure 9: Power Rating Curve

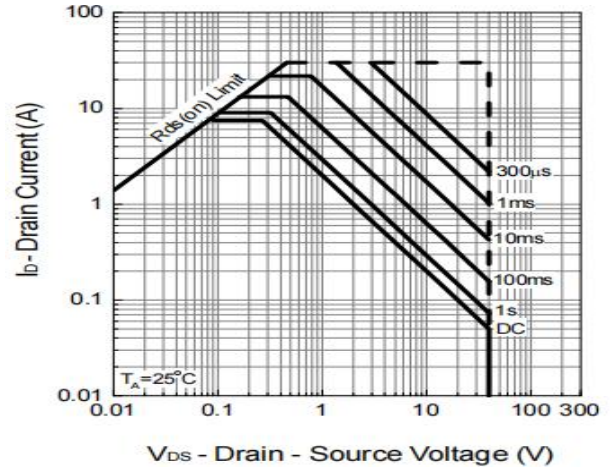

Figure 10: Safe Operating Area

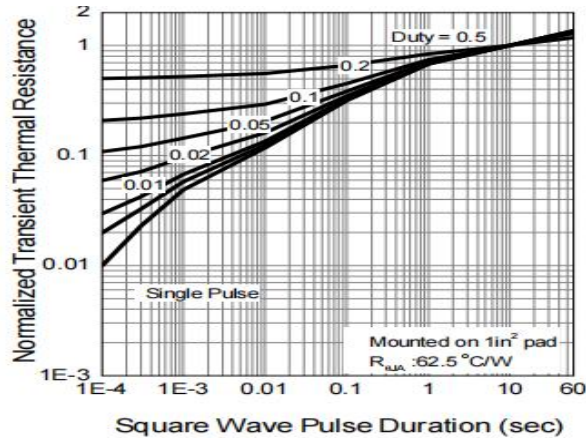

Figure 11: Transient Thermal Response Curve

■ P Typical Characteristic Curve 典型特性曲线

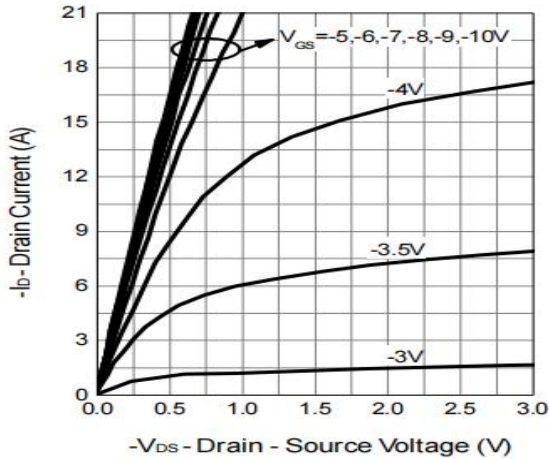

Figure 1: Output Characteristics

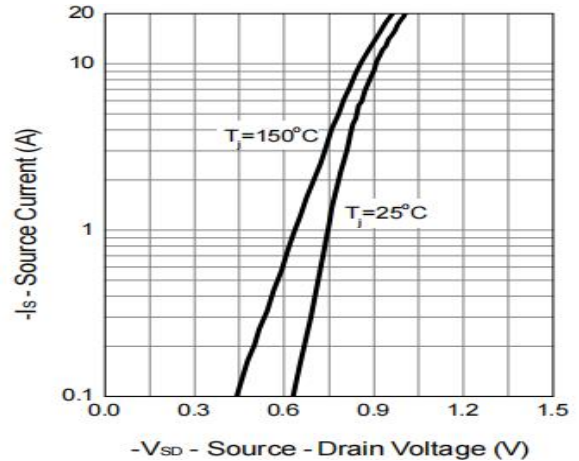

Figure 2: Diode Forward Characteristics

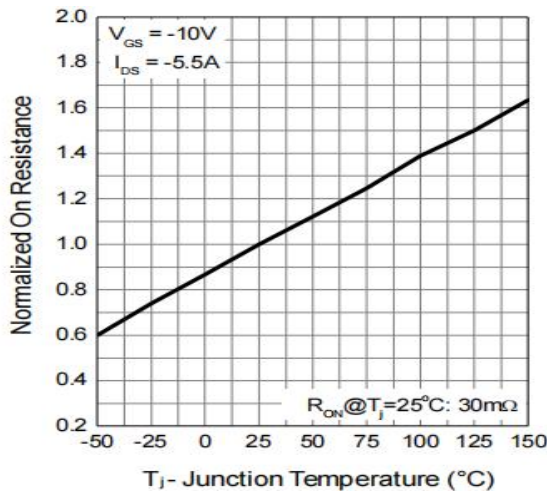

Figure 3: On-Resistance vs.  $T_j$

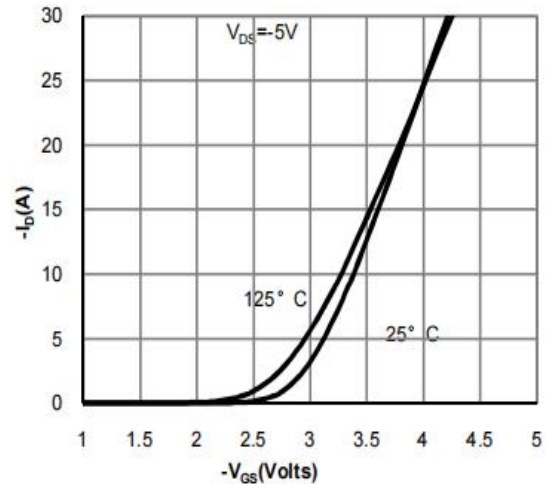

Figure 4: Gate Threshold Voltage

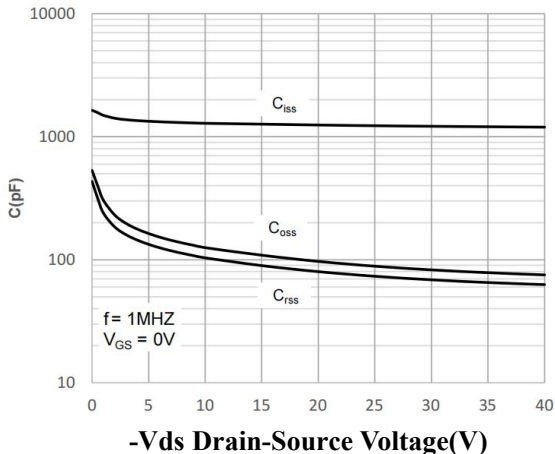

Figure 5: Capacitance Characteristics

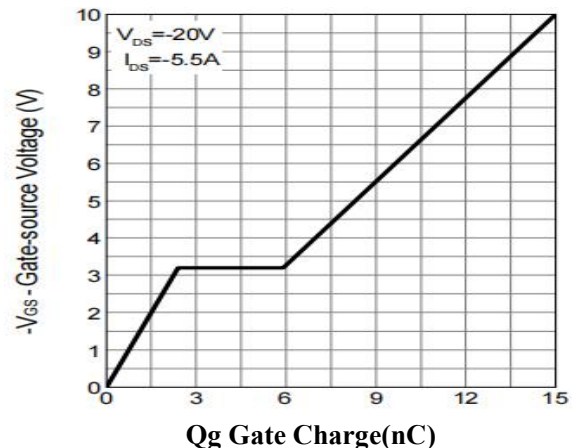

Figure 6: Gate-Charge Characteristics

■ P Typical Characteristic Curve 典型特性曲线

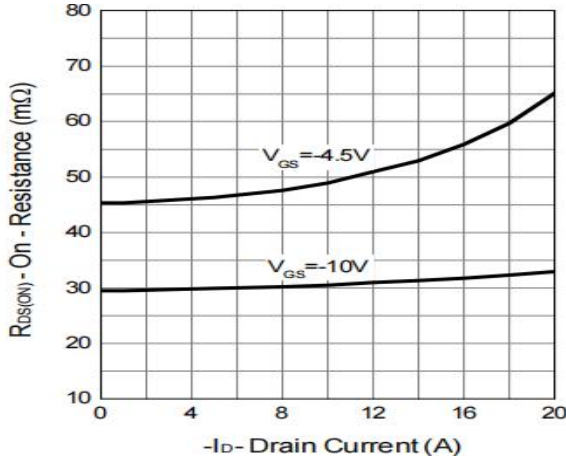

Figure 7: On-Resistance vs. Drain Current

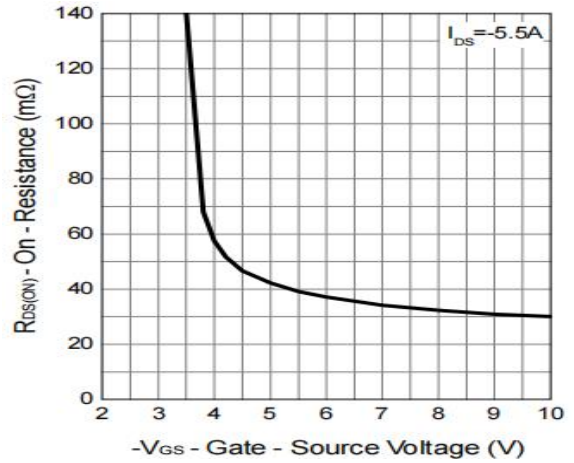

Figure 8: On-Resistance vs.  $V_{GS}$

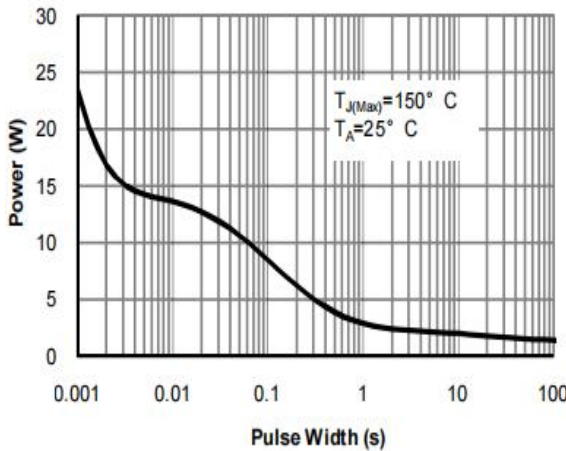

Figure 9: Power Rating Curve

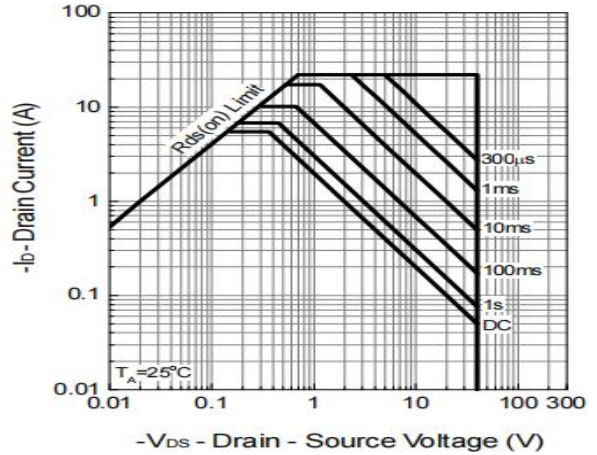

Figure 10: Safe Operating Area

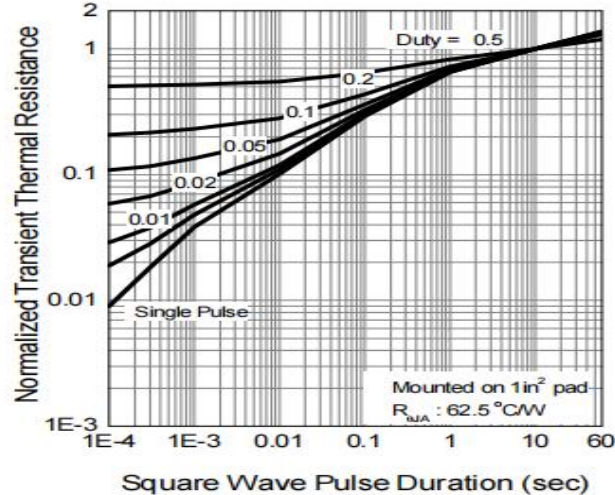
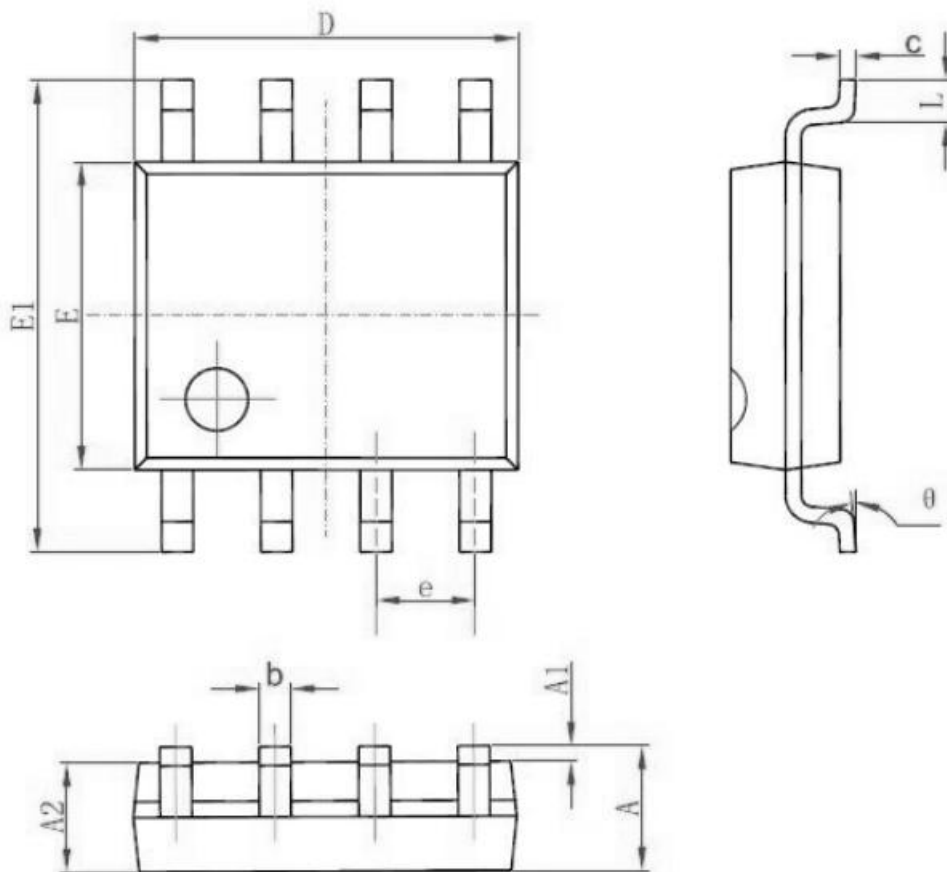

Figure 11: Transient Thermal Response Curve

■ Dimension 外形封装尺寸



Symbol	Dimensions In Millimeters		Dimensions In Inches	
	Min	Max	Min	Max
A	1.350	1.750	0.053	0.069
A1	0.100	0.250	0.004	0.010
A2	1.350	1.550	0.053	0.061
b	0.330	0.510	0.013	0.020
c	0.170	0.250	0.006	0.010
D	4.700	5.100	0.185	0.200
E	3.800	4.000	0.150	0.157
E1	5.800	6.200	0.228	0.244
e	1.270 (BSC)		0.050 (BSC)	
L	0.400	1.270	0.016	0.050
θ	0°	8°	0°	8°